

Infrared Multi Analyzer IM series



10-wavelength, 4-constituent, High-speed/High-repeatability, Multi-interface, Easy to operate

The IM series is an on-line multi IR wavelength analyzer utilizing the infrared absorption technology for measuring product constituent and/or thickness. Signal processing capabilities are built into the compact all-in-one detector unit for easy installation and operation. A maximum of 99 calibration curves can be stored into the detector memory for numerous measurement applications. The detector can be used by itself or connected to a PC/plant control system, as both analog and digital outputs are provided. A remote setting display unit, connectable up to 9 detector units, can be used to setup various detector functions and also displays measured values.

FEATURES

- Up to 10 wavelengths, capable of measuring 4 constituents such as; moisture, film-thickness, organism, and coating-thickness in real time simultaneously.
- Connectivity to multiple interfaces, RS485 (MODBUS), Ethernet (LAN)
- High-speed & High-repeatability (28ms)
- Multi-calculation function
- Self-diagnostic function, easy maintenance.
- Conforms to CE standards

CONFIGURATION

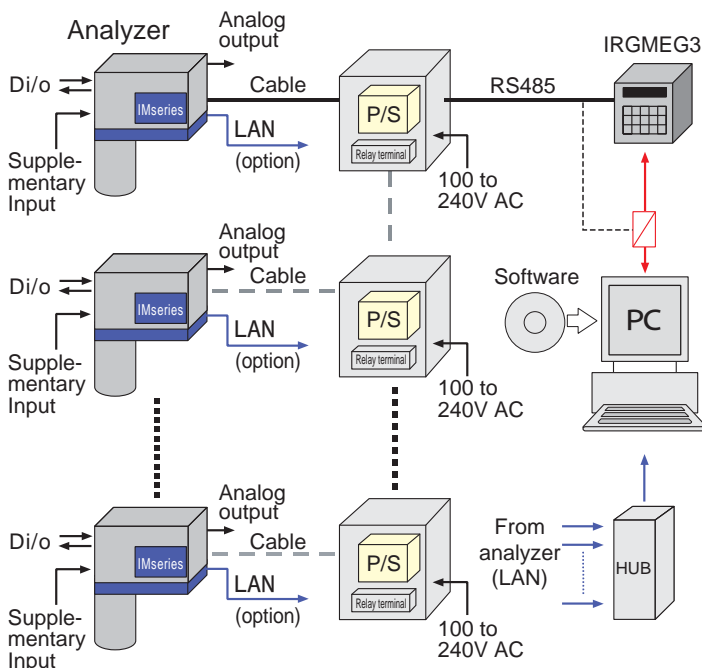

Mirror type

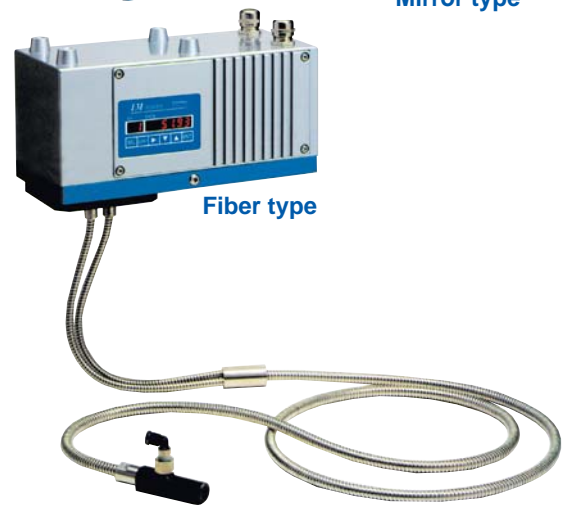

Fiber type



Setting display unit

APPLICATION

- Measuring moisture of wood chip.
- Measuring the thickness of sheet or film.
- Measuring the organism, moisture and lipid of fodder.
- Measuring the organism, moisture and oil of potato chips.
- Measuring moisture of garbage (RDF moisture).
- Measuring the coating thickness on the painting sheet.
- Measuring moisture of powder.
- Measuring moisture in cleaning solution.
- Measuring moisture of clay.
- Measuring moisture of fiber.
- Measure & Control the coating thickness of Laminate-sheet production line.
- Measure & Control the painting thickness.

MODELS

Analyzer unit

IRMA

Type

- 1000 Series ... Moisture (Mirror type)
 - 11 : General moisture
 - 12 : High moisture
 - 13 : Micro moisture
- 2000 Series ... Moisture (Fiber type)
 - 21 : General moisture
 - 22 : High moisture
- 5000 Series ... Multi-component (Mirror type)
 - 51 : Multi-component (NIR)
 - 52 : Multi-component (Thin-film, Infrared)
- 6000 Series ... Multi-component (Fiber type)
 - 61 : Multi-component
- 7000 Series ... Thickness, coating (Mirror type)
 - 71 : Thickness, coating (NIR)
 - 72 : Thin-film, coating (Infrared)
- 8000 Series ... Thickness, coating (Fiber type)
 - 81 : Thickness, coating

Number of measuring wavelength or component

- 00 : Other than 5,000 & 6,000 Series
- : For 5,000 & 6,000 Series
 - : Number of measuring wavelength: 2 to 0 (10)
 - : Number of measuring component: 1 to 4

Communications interface

- S : RS485 (standard) *1
- L : Ethernet (LAN)
- W : SS radio

Special specification *2

- Blank : Standard
- 1 : Small diameter type
- 2 : Rust prevention type
- 3 : Gain specifications
- 4 : P polarized light

*1: RS485 is not applicable when L,W are selected.
 *2: Other special applications in the models are available.

MEASURING EXAMPLES

Object	Range	Accu.
General moisture (%)		
Glass / pottery / cement		
Potter's clay	0 to 12	>±0.3
Iron / metal		
Coal	0 to 15	>±0.2
Mix raw material	0 to 10	>±0.2
Iron oxide	0 to 10	>±0.2
Foods		
Starch	0 to 25	>±0.2
Bread-crumbs	0 to 20	>±0.2
Soybean	0 to 15	>±0.2
Milk powder	0 to 5	>±0.2
Sugar / salt	0 to 2	>±0.05
Flavouring	0 to 10	>±0.2
Tea	0 to 15	>±0.2
Chemicals		
Catalyst	0 to 10	>±0.2
Medium	0 to 20	>±0.2
Detergent	0 to 15	>±0.2
Ink	0 to 5	>±0.2
Fertilizer	0 to 5	>±0.2
Rubber / fiber / etc.		
Vinylon fiber	0 to 10	>±0.2
Acrylic fiber	0 to 10	>±0.2
Wood chip	0 to 10	>±0.2
Paper	0 to 10	>±0.1

High moisture (%)		
Plaster	5 to 15	>±0.7
Wet paper	40 to 70	>±0.5
Raw bread crumbs	30 to 40	>±0.7
Clay	0 to 30	>±0.3
Silica sand	0 to 10	>±0.8
Bicarbonate	0 to 18	>±0.6
Micro moisture (%)		
ABS, PVC powder	0 to 1	>±0.08
Granular ferrite	0 to 0.5	>±0.08
Thickness (μm)		
Polyethylene PE	10 to 3000	>±0.2
Polypropylene PP		>±0.2
Polyester PET		>±0.2
Vinyl chloride PVC		>±0.2
PVA		>±0.2
EVA		>±0.2
Polystyrene PS		>±0.2
Polycarbonate		>±0.2
Nylon PA		>±0.2
Polyimide PI		>±0.3
TAC film	>±0.2	
Coating (g/m²)		
Coat-paper	10 to 1000	>±0.2
Tuck-paper, label		>±0.2
Adhesive WET/DRY		>±0.2
Resin on steel-board		>±0.2

SOFTWARE PACKAGE

● **Main Screen**

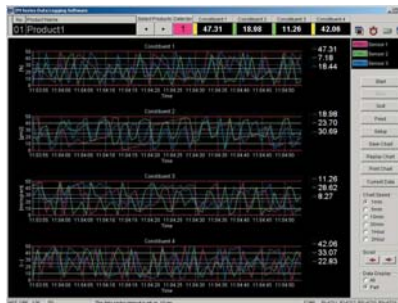

Displays measured data, trend and alarm value. Displays 4 constituents on one screen. Save data into specified folder, enable to search or read out the data.

● **Create the Calibration Curve**

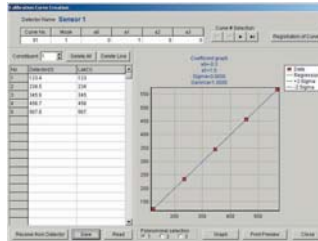

Creates the calibration curve for new sample, and transmits the regression type data to detector.

● **Setup Screen**



MODELS

Setting display unit

IRGMEG3

Communications interface

- R: RS232C (standard)
- A: RS422A (option)
- S: RS485



Setting display unit

■ GENERAL SPECIFICATIONS

● INFRARED MULTI ANALYZER

Measuring system: Infrared absorption type
 Measuring wavelength: Up to 10 wavelengths
 Measuring component: Up to 4 constituents
 Light source: Tungsten lamp
 Measuring distance: 200 to 400mm
 (IRMA1300: 160 to 300mm)
 Measuring diameter: 50mm□/300mm
 (IRMA1300: 30mm□/200m)
 Analog output: 4 to 20mADC, 0.2% of full scale
 (Load resistance: less than 500Ω)
 Communications: RS485 MODBUS
 Output renewal cycle: 28ms
 Display & setup: Displays data & setup parameter
 Parameters are configurable by key
 Computing: 2 or 3-color ratio calculation
 Multiple regression calculation
 No. of calibration curve: Up to 99 curves
 Calibration curve: Linear, quadratic, cubic & multiple regression line
 Calibration curve correction: Linear & quadratic correction
 Smoothing (delay): 0 to 99 seconds
 Calibration: By checking plate
 Detector No. setup: When multiple detector operation,
 detector No. is key configurable
 Channel No. setup: Calibration curve No. is key configurable.
 Self-diagnostic: Outputs contact signal and communications when
 abnormal conditions
 Correction input: Compensate measured value
 by external 4 to 20mA DC
 (sample temperature, etc.)
 External Di/o: Di(contact input) --- Perform either one of preset,
 data-hold or real/smoothing
 Do(contact output) --- Selects self
 -diagnostic(1b) or Hi/low alarm(1a)
 Working temperature: 0 to 50C (Use dry air cooling if higher than 45C
 Outlet air temperature must be lower than 30C)
 Power supply: 24V DC supplied from IR-WEP
 (IR-WEP power supply: 100-240VAC)
 Power consumption: Approx. 30VA
 Connection: Terminal connection
 Casing: Aluminum casting
 Weight: Approx. 4.3kg
 Mounting: Bolt suspension method with 4 pieces of M8 bolts
 CE-standards: EN61326-1:2006
 Emission : Class A
 Immunity : Table 2

■ SPECIAL SPECIFICATIONS

Specifications	Content
Small diameter	Mirror reflection type 30mm□
Rust prevention	For inside printed-circuit board
Gain specification	Special sample * Judged by sample test
P polarized light	Thin-film sample * Judged by sample test

● SETTING DISPLAY UNIT

Input signal: RS485, up to 9 detectors connectable
 Analog output: 4 to 20 mA DC, 3 output (Load resistance :
 output 1, 2 : Less than 600Ω, 3 : Less than 400Ω)
 (Component 1 of detector no.1 to 3 is outputed for
 multi head)
 Communications: RS232C(standard), RS422A or RS485(option)
 Output renewal cycle: 28ms x detector number
 Display: 1. Measured data, LED 5 digit
 2. Detector No., component No., calibration curve
 No., parameter setup
 (Component No. is displayed for detector multi-
 component meter)
 Detector No. setup: Detector No. 1 to 9 is key configurable
 Component No. setup: Component No. 1 to 4 is key configurable
 (Depending on the detector)
 Calibration curve No. setup: Calibration curve No. is key configurable for each
 of detector No. also configurable by external contact
 Smoothing time: Smoothing time setting at smoothing calculation
 T=0.0 to 9.9, 10 to 99 seconds
 Calibration function: Perform calibration by key operation or by external
 contact in use of checking plate
 Hold / preset: Hold or preset the display and output by key
 operation or by external contact
 Calibration curve correction: Online correction of calibration curve linear and
 quadratic correction
 External setup: Detector No., component No., calibration curve No.,
 calibration, hold or preset
 Alarm function: High/low limit alarm individual contact output (a
 contact, common) beyond setting range
 Self-diagnostic: Outputs contact signal(1b) when abnormal condition
 Case material: Flame retardant polycarbonate
 Working ambient: 0 to 50°C
 Mounting: Panel-mount type
 Weight: Approx. 0.6kg
 Power supply: 100 to 240V AC 50/60Hz
 Power consumption Max. 20VA
 CE-standards: EN61326-1:2006
 Emission : Class A
 Immunity : Table 2

● FIBER UNIT

Measuring distance and diameter:
 With lens --- $\varnothing 25/25\text{mm}$ to $\varnothing 40/100\text{mm}$
 Without lens --- $\varnothing 20/15\text{mm}$ to $\varnothing 50/50\text{mm}$
 Fiber length: Standard 1.5m, Max.5m (Reflection type fiber)
 Standard 2m, Max.10m (Transmission type fiber)
 Fiber protection: Stainless steel flexible armour
 Minimum bending radius: R100mm
 Working temperature: 0 to 150°C
 Purge air flow: With lens --- Air purge disabled
 Without lens --- 5 to 20L/min
 Accessory: Vertical mounting holder
 Flange holder

EXTERNAL DIMENSIONS

Analyzer IRMA

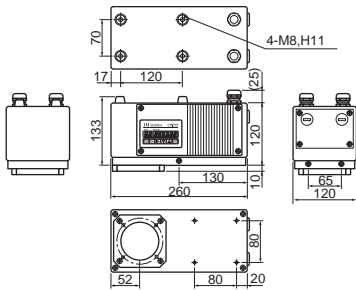

Setting display unit IRGMEG3

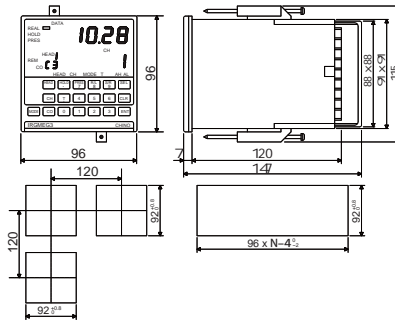

Power supply unit IR-WEP

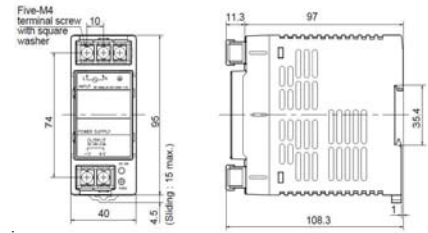

Air purge hood IR-WEA

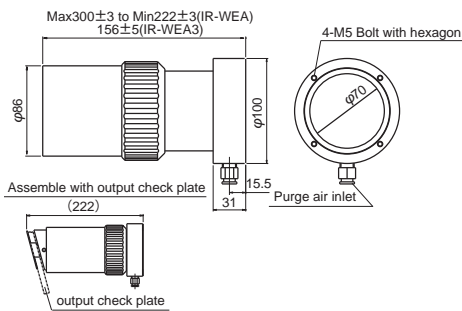

Output checking plate IR-WEB

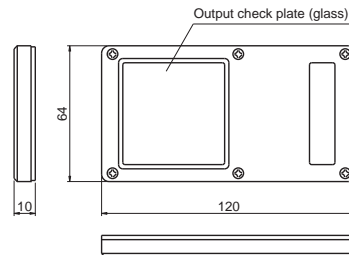

Connecting cable IR-WERP□□□

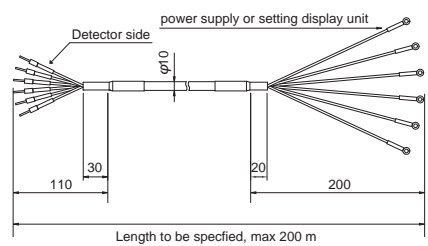

Reflection type fiber (without lens) IR-WCRN□□□

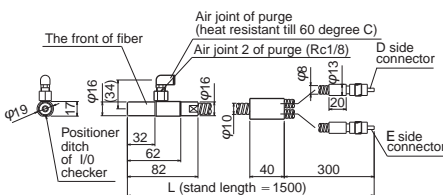

Reflection type fiber (with lens) IR-WCRE□□□

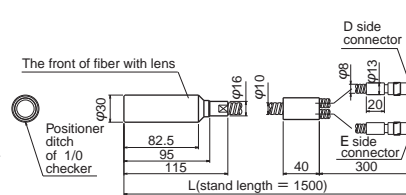

Transmission type fiber IR-WCT□□□

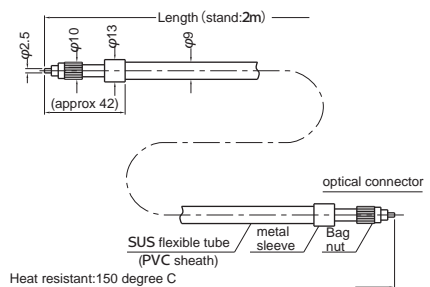

Output checking plate for reflection type fiber IR-WCR□B

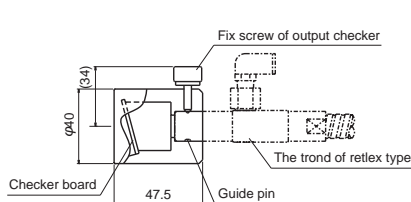

Liquid cell IR-WCC

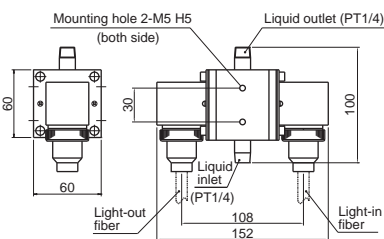

Air-cooling box IR-WEX

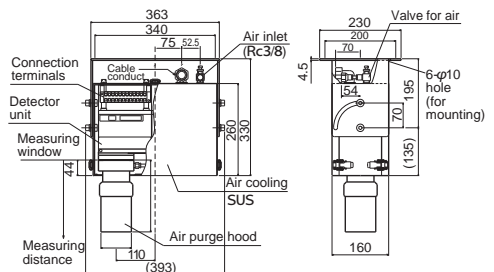

Unit: mm

Specifications subject to change without notice. Printed in Japan (I) 2019. 3

CHINO CORPORATION

32-8 KUMANO-CHO, ITABASHI-KU, TOKYO 173-8632
 Telephone : +81-3-3956-2171
 Facsimile : +81-3-3956-0915
 E-mail : inter@chino.co.jp
 Website : http://www.chino.co.jp/